

MBR2060CT&MBR2060FCT

20.0AMPS. SCHOTTKY BARRIER RECTIFIERS

FEATURE

- . High current capability
- . Low forward voltage drop
- . Low power loss, high efficiency
- . High surge capability
- . High temperature soldering guaranteed
260°C /10seconds, 0.25"(6.35mm)from case.

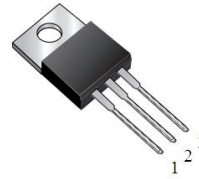

TO-220AB-3L
MBR2060CT

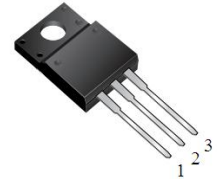

TO-220F-3L
MBR2060FCT

MECHANICAL DATA

- . Case: Molded with UL-94 Class V-0 recognized
Flame Retardant Epoxy
- . Mounting position: any

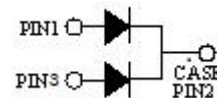

Single phase, half wave, 60Hz,resistive or inductive load.

For capacitive load, derate current by 20%

MAXIMUM RATINGS (T_C=25°C unless otherwise noted)

| Parameter | Symbol | MBR2060CT&MBR2060FCT | Units |
|--|-----------------------------------|----------------------|-------|
| Maximum Recurrent Peak Reverse Voltage | V _{RRM} | 60 | V |
| Maximum RMS Voltage | V _{RMS} | 42 | V |
| Maximum DC blocking Voltage | V _{DC} | 60 | V |
| Maximum Average Forward Rectified Current <i>Per Leg</i> At T _C =100°C <i>Total device</i> | I _{F(AV)} | 10.0 20.0 | A |
| Peak Forward Surge Current 8.3ms single half sine-wave superimposed on rated load (JEDEC method) <i>Per Leg</i> | I _{FSM} | 150.0 | A |
| Typical Junction Capacitance (Note 1) | C _J | 377 | pF |
| Operation Junction Temperature and Storage Temperature | T _J , T _{STG} | -55 to +150 | °C |

ELECTICAL CHARACTERISTICS-(per leg) (T_A=25°C unless otherwise noted)

| Parameter | Symbol | Test conditions | Typ | Max | Units | |
|-------------------------|----------------|-----------------------|---------------------|------|-------|----|
| Forward voltage drop | V _F | T _J =25°C | I _F =3A | 0.53 | --- | V |
| | | | I _F =5A | 0.59 | --- | |
| | | | I _F =10A | 0.70 | 0.80 | |
| | | T _J =125°C | I _F =3A | 0.45 | --- | |
| | | | I _F =5A | 0.51 | --- | |
| | | | I _F =10A | 0.61 | 0.71 | |
| Reverse leakage current | I _R | T _J =25°C | V _R =60V | --- | 100 | μA |
| | | T _J =125°C | V _R =60V | --- | 20 | mA |

THERMAL CHARACTERISTICS(T_C=25°C unless otherwise noted)

| Parameter | Symbol | MBR2060CT | MBR2060FCT | Units |
|-------------------------------------|-------------------|-----------|------------|-------|
| Typical Thermal Resistance (Note 2) | R _(JC) | 2.0 | 3.0 | °C/W |

Notes:

1. Measured at 1.0 MHz and applied reverse voltage of 4.0Vdc
2. Thermal Resistance from Junction to Case

RATING AND CHARACTERISTIC CURVE

FIG.1-TYPICAL FORWARD CURRENT DERATING CURVE

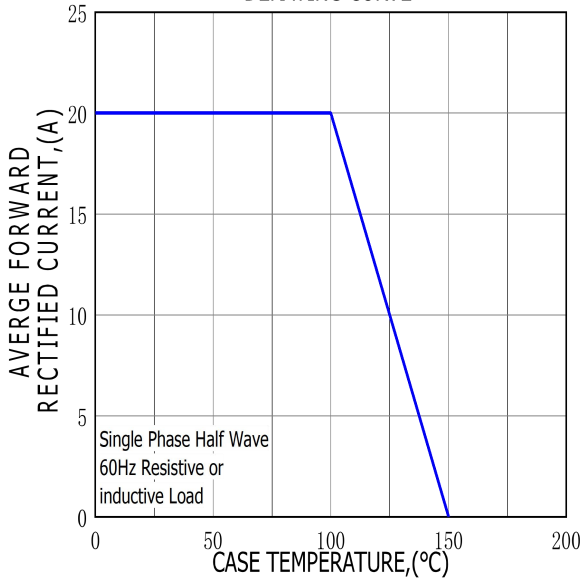

FIG.2-TYPICAL INSTANTANEOUS FORWARD CHARACTERISTICS

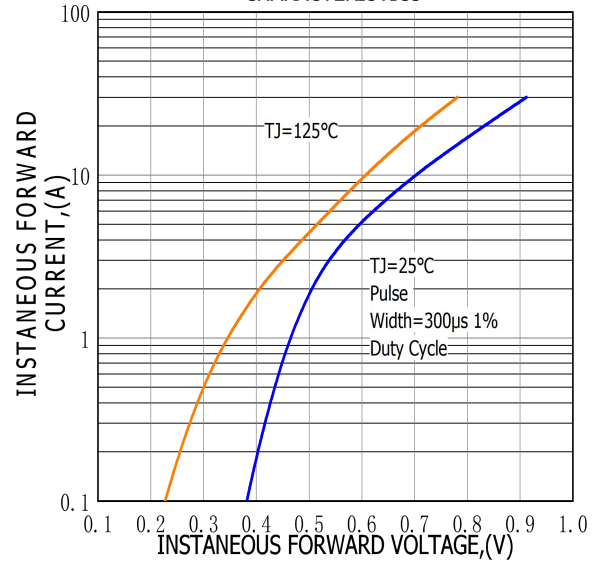

FIG.3-MAXIMUM NON-REPETITIVE FORWARD SURGE CURRENT

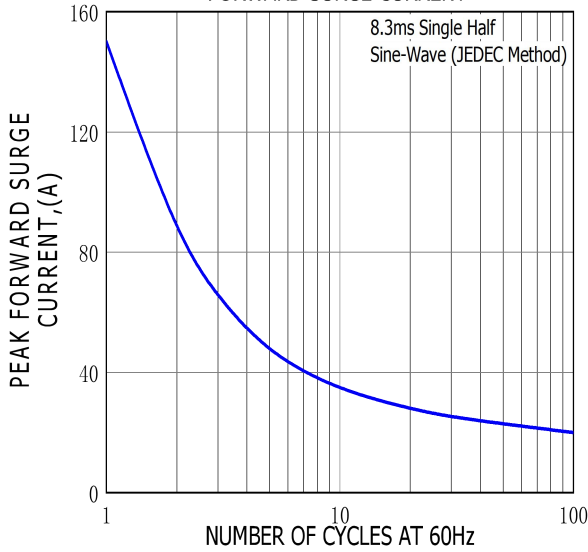
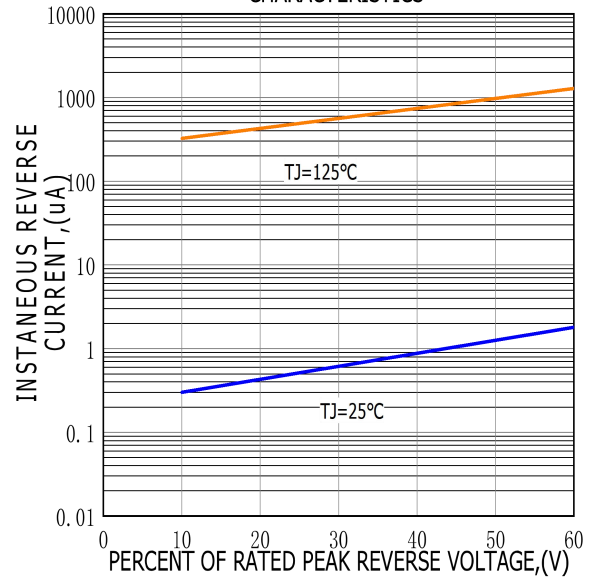
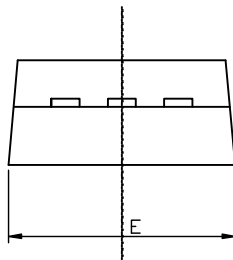
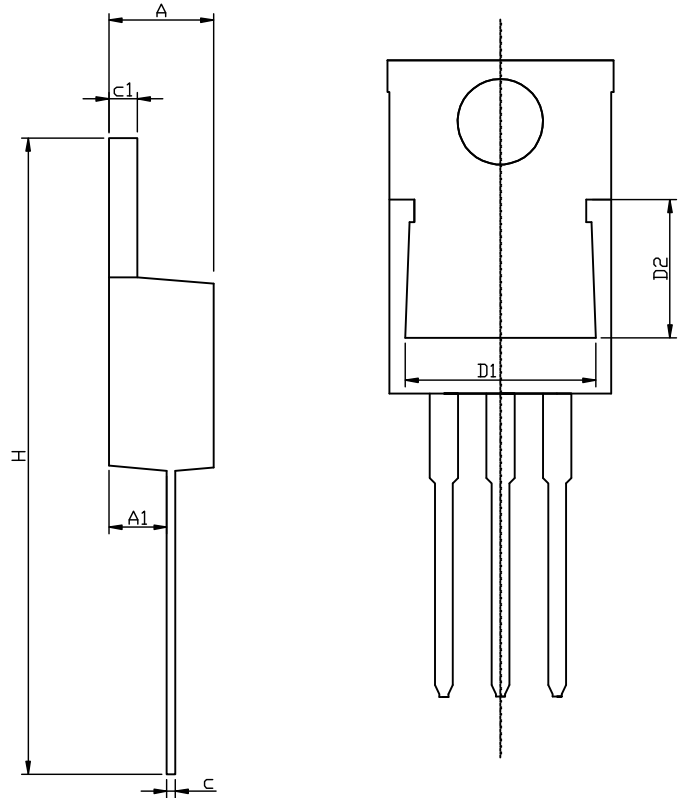
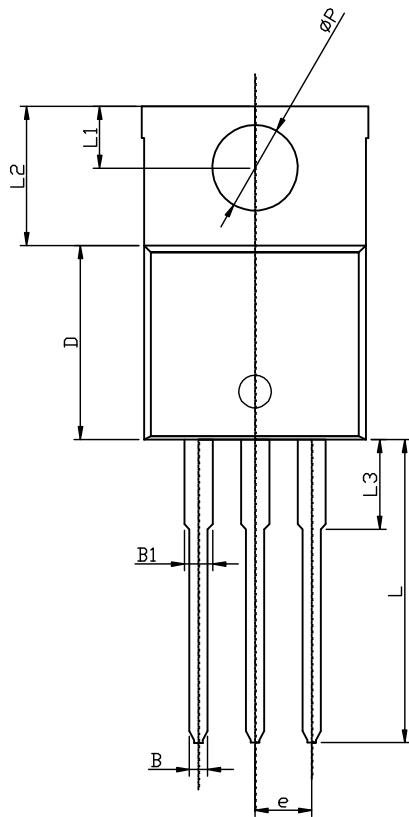

FIG.4-TYPICAL REVERSE CHARACTERISTICS



TO-220AB-3L PACKAGE OUTLINE



RECOMMENDED LAND PATTERN

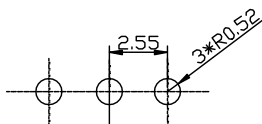

UNIT: mm

| | MIN | NOM | MAX |
|----------|-------|-------|-------|
| A | 4.50 | 4.70 | 4.90 |
| A1 | 2.45 | 2.60 | 2.70 |
| B | 0.72 | 0.82 | 0.92 |
| B1 | 1.12 | 1.27 | 1.42 |
| c | 0.28 | 0.38 | 0.48 |
| c1 | 1.17 | 1.27 | 1.37 |
| D | 8.46 | 8.66 | 8.86 |
| D1 | 7.90 | 8.10 | 8.40 |
| D2 | 5.50 | 5.70 | 5.90 |
| e | 2.45 | 2.55 | 2.65 |
| E | 9.85 | 10.15 | 10.45 |
| H | 28.00 | 28.50 | 29.00 |
| ϕP | | 3.84 | |
| L | 13.1 | 13.6 | 14.1 |
| L1 | 2.54 | 2.74 | 2.94 |
| L2 | 6.04 | 6.24 | 6.44 |
| L3 | 3.85 | 4.05 | 4.35 |

TO-220F-3L PACKAGE OUTLINE

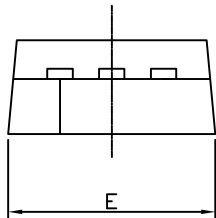
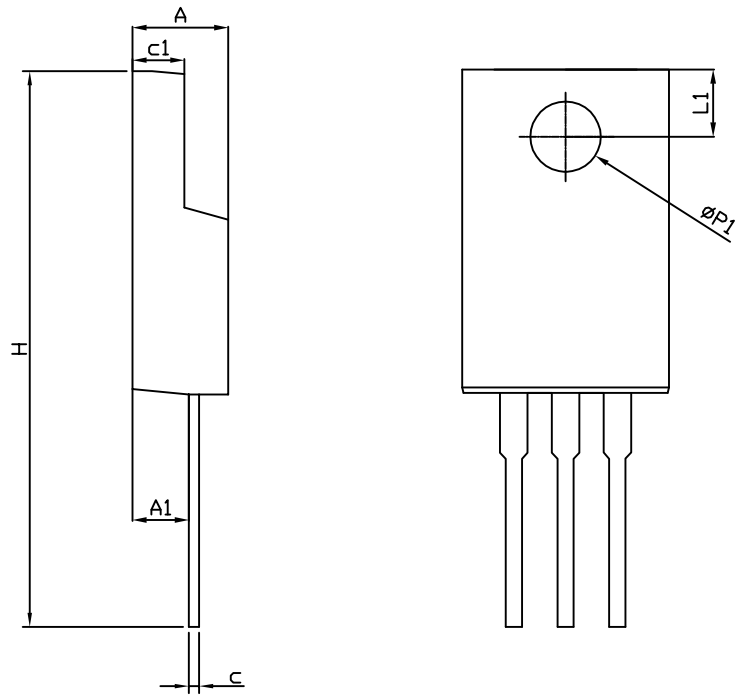
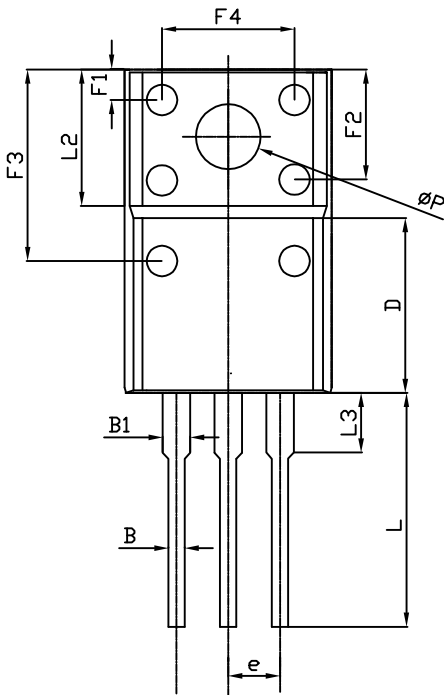

RECOMMENDED LAND PATTERN

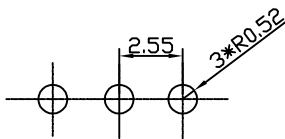

UNIT: mm

| | MIN | NOM | MAX |
|-----------|-------|---------|-------|
| A | 4.40 | 4.60 | 4.80 |
| A1 | 2.63 | 2.76 | 2.89 |
| B | 0.75 | 0.80 | 0.90 |
| B1 | 1.12 | 1.27 | 1.42 |
| c | 0.40 | 0.50 | 0.60 |
| c1 | 2.60 | 2.70 | 2.80 |
| D | 7.50 | 7.80 | 8.10 |
| e | - | 2.55REF | - |
| E | 9.86 | 10.00 | 10.10 |
| F1 | 1.90 | 2.12 | 2.40 |
| F2 | 5.00 | 5.30 | 5.65 |
| F3 | 8.70 | 9.00 | 9.30 |
| F4 | 6.20 | 6.50 | 6.80 |
| H | 27.80 | 28.30 | 28.80 |
| L | 13.10 | 13.30 | 13.50 |
| L1 | 2.85 | 3.00 | 3.15 |
| L2 | - | 6.70REF | - |
| L3 | 2.80 | 3.10 | 3.40 |
| ΦP | 3.00 | 3.30 | 3.60 |
| $\Phi P1$ | 2.80 | 3.10 | 3.40 |