

**SB2100**

**2.0AMPS. SCHOTTKY BARRIER RECTIFIERS**

**FEATURE**

- . High current capability
- . Low forward voltage drop
- . Low power loss, high efficiency
- . High surge capability
- . High temperature soldering guaranteed  
260°C /10sec/ 0.375" lead length at 5 lbs tension

**MECHANICAL DATA**

- . Terminal: Plated axial leads solderable per MIL-STD 202E, method 208C
- . Case: Molded with UL-94 Class V-0 recognized Flame Retardant Epoxy
- . Polarity: color band denotes cathode
- . Mounting position: any

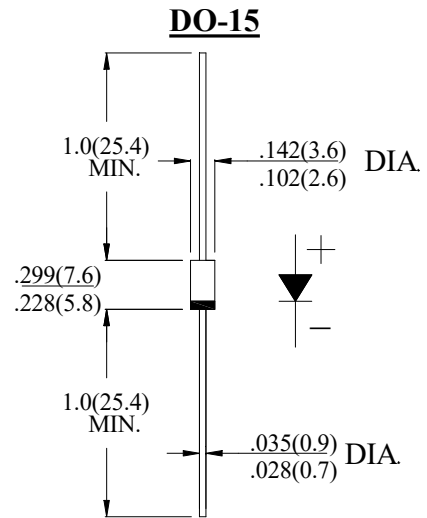

Dimensions in inches and (millimeters)

**MAXIMUM RATINGS AND ELECTRICAL CHARACTERISTICS**

Ratings at 25°C ambient temperature unless otherwise specified.

Single phase, half wave, 60Hz, resistive or inductive load. For capacitive load, derate current by 20%

Type Number	SYM BOL	SB2100	units
Maximum Recurrent Peak Reverse Voltage	$V_{RRM}$	100	V
Maximum RMS Voltage	$V_{RMS}$	70	V
Maximum DC blocking Voltage	$V_{DC}$	100	V
Maximum Average Forward Rectified Current .375"(9.5mm) lead length	$I_{F(AV)}$	2.0	A
Peak Forward Surge Current 8.3ms single half sine-wave superimposed on rated load (JEDEC method)	$I_{FSM}$	50.0	A
Maximum Forward Voltage at 2.0A DC	$V_F$	0.85	V
Maximum DC Reverse Current @ $T_J=25^\circ\text{C}$ at rated DC blocking voltage @ $T_J=100^\circ\text{C}$	$I_R$	0.1 10.0	mA
Typical Junction Capacitance (Note 1)	$C_J$	65	pF
Typical Thermal Resistance (Note 2)	$R_{(JA)}$	70	°C/W
Storage Temperature	$T_{STG}$	-55 to +150	°C
Operation Junction Temperature	$T_J$	-55 to +150	°C

**Note:**

1. Measured at 1.0 MHz and applied reverse voltage of 4.0Vdc
2. Thermal Resistance from Junction to Ambient at 0.375" (9.5mm) lead length, vertical P.C.Board Mounted.

**RATING AND CHARACTERISTIC CURVES**

FIG.1-TYPICAL FORWARD CURRENT DERATING CURVE

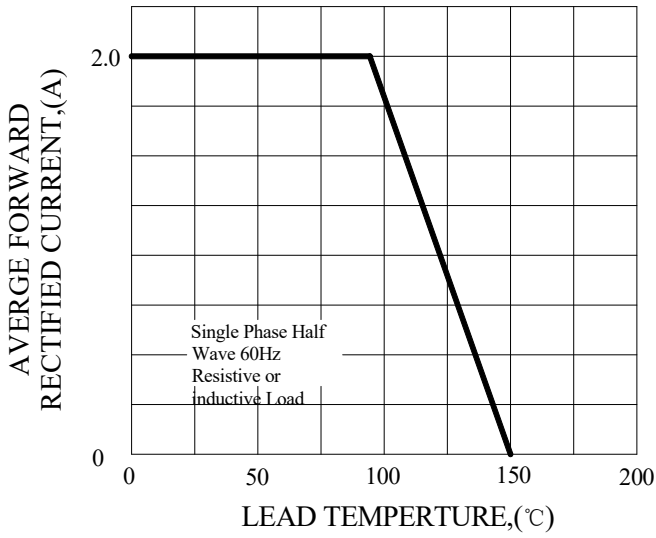

FIG.2-TYPICAL INSTANTANEOUS FORWARD CHARACTERISTICS

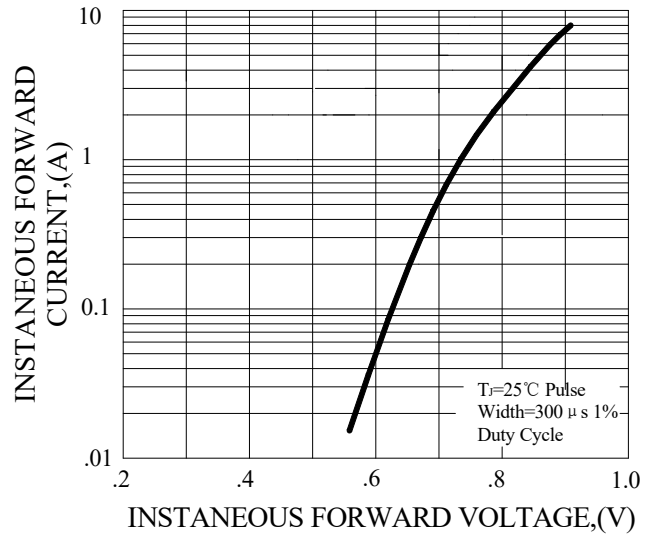

FIG.3-MAXIMUM NON-REPETITIVE FORWARD SURGE CURRENT

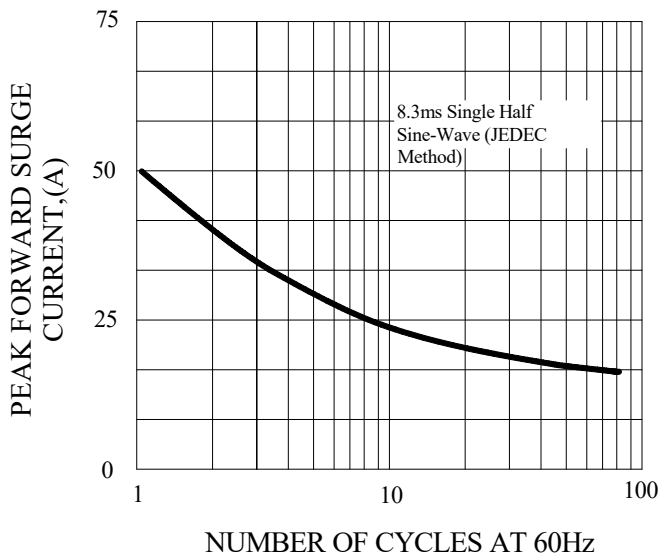
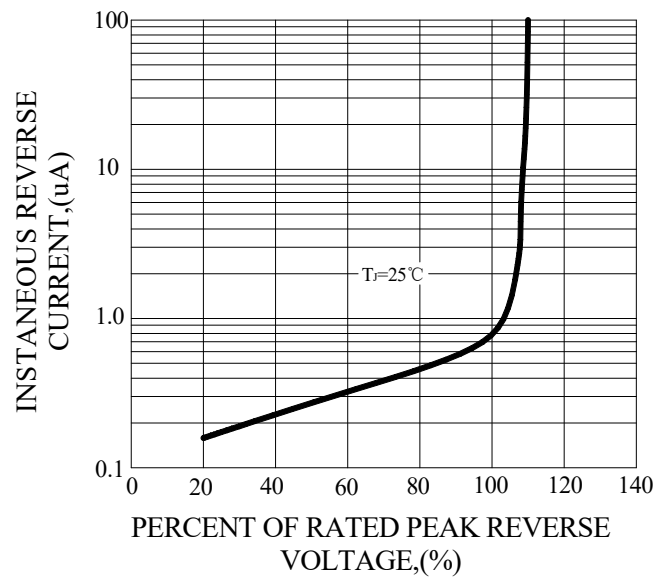
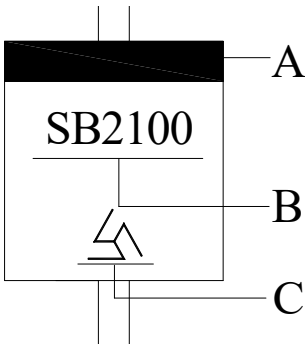

FIG.4-TYPICAL REVERSE CHARACTERISTICS



## Marking and packaging illustration

### 1、Marking



SYMBOL	Explanation
<b>A</b>	Color Band Denotes Cathode
<b>B</b>	Product Name
<b>C</b>	Trademark

### 2、Packaging

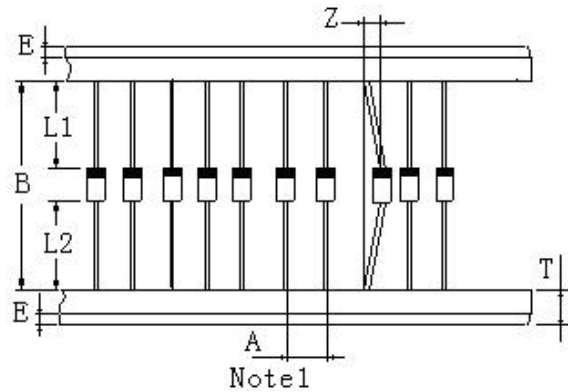

ITEM	SYMBOL	SPECIFICATIONS	
		(mm)	(inch)
Component alignment	Z	1.2max	0.048max
Tape width	T	6.0±0.4	0.2±0.016
Exposed adhesive	E	0.8max	0.032max
Body eccentricity	L1-L2	1.0max	0.040max
Component	A	5.0±0.5	0.2±0.02
Inner tap	B	52.0~53.5	2.06~2.11
NOTE: Each component lead shall be sandwiched between tapes for a minimum of 2.5mm (0.1inch)			