

SS510LR

5.0AMPS. SCHOTTKY BARRIER RECTIFIERS

FEATURE

- . For surface mounted application
- . High current capability
- . Low forward voltage drop
- . Low power loss, high efficiency
- . High surge current capability
- . High temperature soldering guaranteed:
260°C/10 seconds at terminals.

MECHANICAL DATA

- . Terminal: Solder plated
- . Case: Molded with UL-94 Class V-0 recognized
Flame Retardant Epoxy
- . Polarity: color band denotes cathode
- . Packaging: 12mm tape per EIA STD RS-481

SMC (DO-214AB)

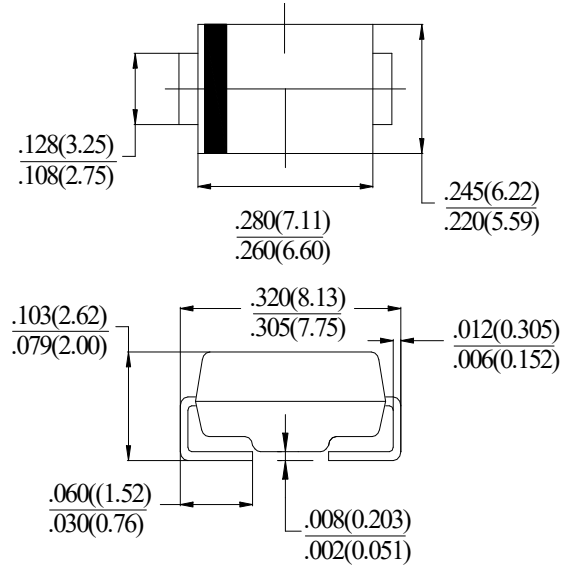

Dimensions in inches and (millimeters)

MAXIMUM RATINGS AND ELECTRICAL CHARACTERISTICS

Ratings at 25°C ambient temperature unless otherwise specified.

Single phase, half wave, 60Hz, resistive or inductive load.

For capacitive load, derate current by 20%

| Type Number | SYM BOL | SS510LR | units |
|---|-------------|-------------|-------|
| Maximum Recurrent Peak Reverse Voltage | V_{RRM} | 100 | V |
| Maximum RMS Voltage | V_{RMS} | 70 | V |
| Maximum DC blocking Voltage | V_{DC} | 100 | V |
| Maximum Average Forward Rectified Current .375"(9.5mm) lead length at $T_L = 90^\circ\text{C}$ | $I_{F(AV)}$ | 5.0 | A |
| Peak Forward Surge Current 8.3ms single half sine-wave superimposed on rated load (JEDEC method) | I_{FSM} | 120.0 | A |
| Maximum Forward Voltage at 5.0A DC | V_F | 0.75 | V |
| Maximum DC Reverse Current @ $T_A = 25^\circ\text{C}$ at rated DC blocking voltage @ $T_A = 100^\circ\text{C}$ | I_R | 0.1 10.0 | mA |
| Typical Junction Capacitance (Note 1) | C_J | 112 | pF |
| Typical Thermal Resistance (Note 2) | $R_{(JA)}$ | 55 | °C/W |
| Storage Temperature | T_{STG} | -55 to +150 | °C |
| Operation Junction Temperature | T_J | -55 to +150 | °C |

Note:

1. Measured at 1.0 MHz and applied reverse voltage of 4.0Vdc
2. Measured on P.C.Board with 0.2×0.2"(5.0×5.0mm)Copper Pad Areas.

RATING AND CHARACTERISTIC CURVES (SS510LR)

FIG.1-TYPICAL FORWARD CURRENT DERATING CURVE

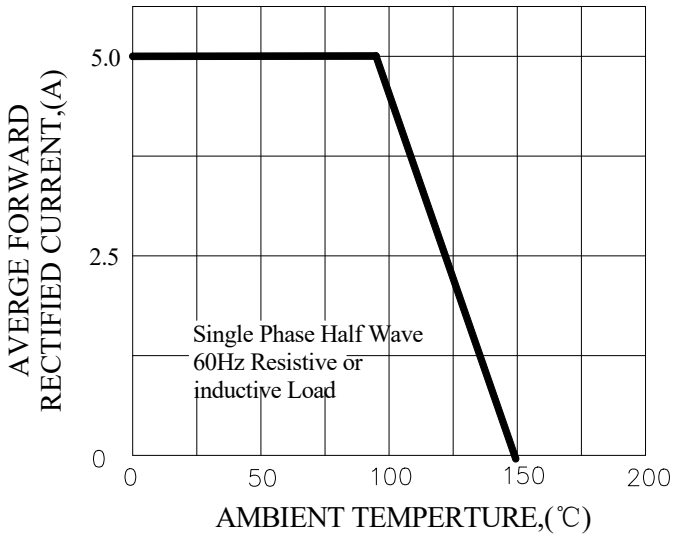

FIG.2-TYPICAL INSTANTANEOUS FORWARD CHARACTERISTICS

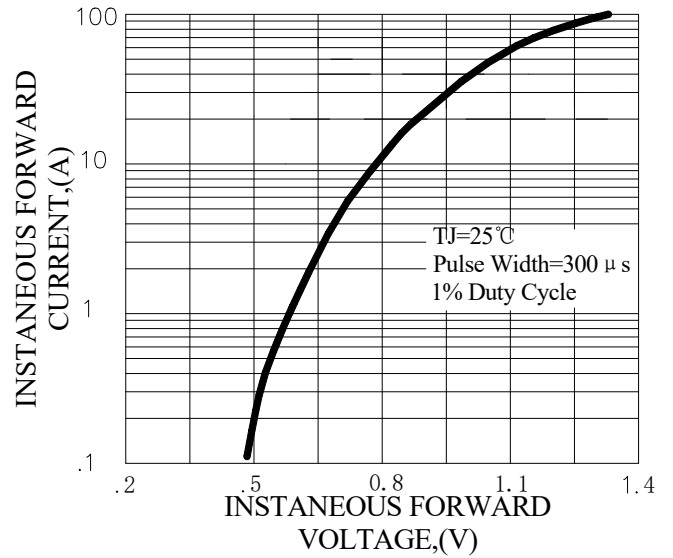

FIG.3-MAXIMUM NON-REPETITIVE FORWARD SURGE CURRENT

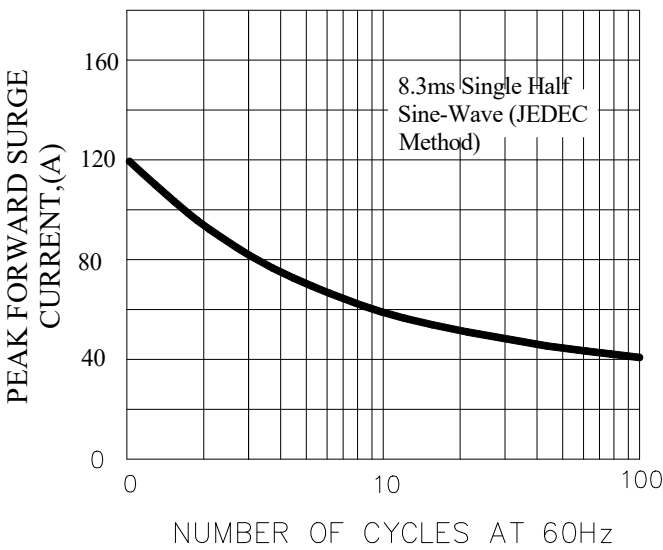
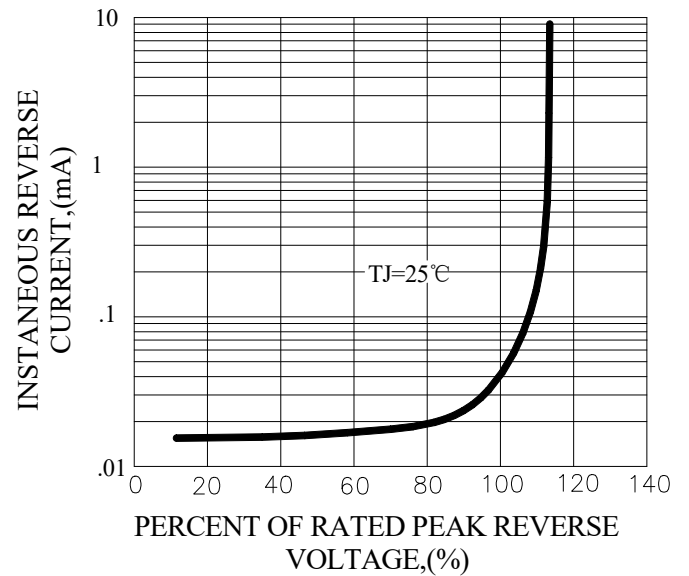
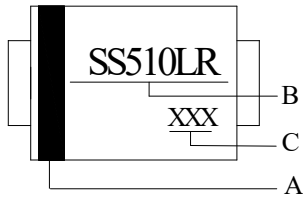

FIG.4-TYPICAL REVERSE CHARACTERISTICS



Marking and packaging illustration

1、Marking



| SYMBOL | Explanation |
|----------|-----------------------------------|
| A | Color Band Denotes Cathode |
| B | Product Name |
| C | Date Code |

2、Packaging

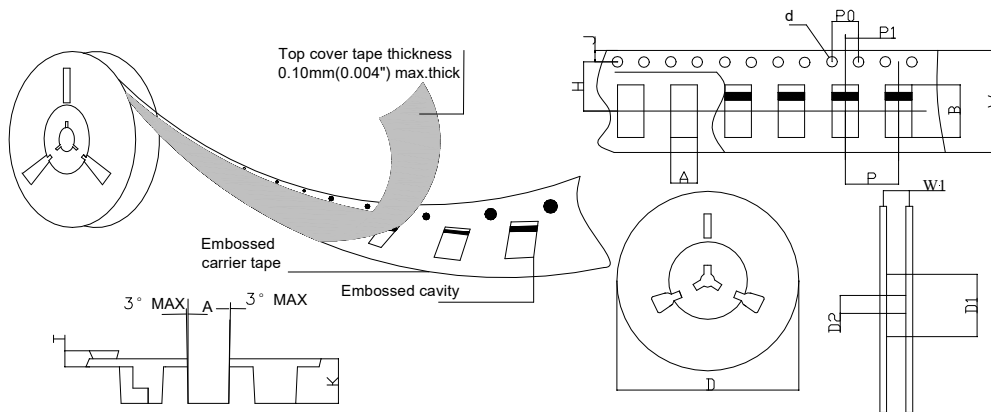

| SPECIFICATIONS mm(inch) | | PACKAGE |
|----------------------------|----|-----------------|
| SYMBOL | | SMC(DO-214AB) |
| ITEM | | |
| Carrier width | A | 6.15(0.242)Max |
| Carrier length | B | 8.41(0.331)Max |
| Sprocket hole | d | ø1.55(0.061)Typ |
| Reel outer diameter | D | 330.0(13.0)Typ |
| Reel inner diameter | D1 | 74.0(2.913)Min |
| Feed hole diameter | D2 | 13.0(0.512)Typ |
| Sprocket hole position | J | 1.75(0.069)Typ |
| Punch hole position | H | 7.50(0.295)Typ |
| Carrier depth | K | 2.54(0.100)Typ |
| Punch hole pitch | P | 8.00(0.315)Typ |
| Sprocket hole pitch | P0 | 4.00(0.157)Typ |
| Embossment center | P1 | 2.00(0.079)Typ |
| Overall tape thickness | T | 0.25(0.010)Typ |
| Tape width | W | 16.0(0.430)Typ |
| Reel width | W1 | 16.5(0.650)Min |