

## ABSR210-70

### SINGLE PHASE 2.0A MPS. GLASS PASSIVATED FAST BRIDGE RECTIFIERS

#### FEATURE

- . Glass passivated junction.
- . Ideal for printed circuit board.
- . Reliable low cost construction utilizing molded plastic technique.
- . High surge current capability.
- . High temperature soldering guaranteed:  
260°C/10 seconds at terminals.
- . Small size, simple installation.

#### MECHANICAL DATA

- . Case: Molded plastic
- . Epoxy: UL 94V-0 rate flame retardant
- . Lead: MIL-STD- 202E, Method 208 guaranteed
- . Polarity: As marked

#### ABS

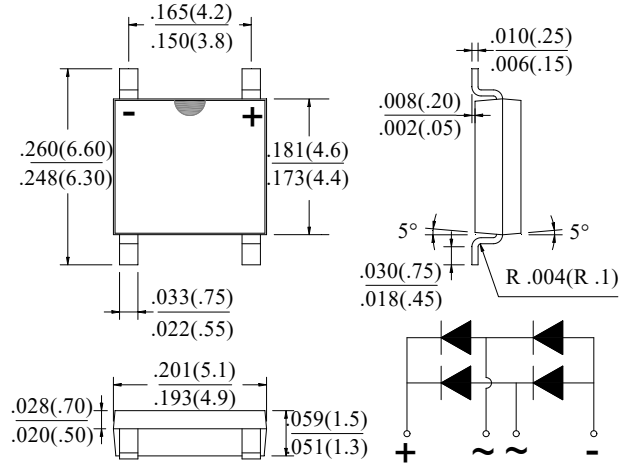

Dimensions in inches and (millimeters)

### MAXIMUM RATINGS AND ELECTRICAL CHARACTERISTICS

Ratings at 25°C ambient temperature unless otherwise specified.

Single phase, half wave, 60Hz, resistive or inductive load. For capacitive load, derate current by 20%

Type Number	SYM BOL	ABSR210-70	units
Maximum Recurrent Peak Reverse Voltage	$V_{RRM}$	1000	V
Maximum RMS Voltage	$V_{RMS}$	700	V
Maximum DC blocking Voltage	$V_{DC}$	1000	V
Maximum Average Forward rectified Current @ $T_A=40^\circ\text{C}$	$I_{F(AV)}$	2.0	A
Peak Forward Surge Current 8.3ms single half sine-wave superimposed on rate load (JEDEC method)	$I_{FSM}$	70.0	A
Maximum Instantaneous Forward Voltage at 2.0A DC at 0.8 A DC	$V_F$	1.30 1.25	V
Maximum DC Reverse Current @ $T_J=25^\circ\text{C}$ at rated DC blocking voltage @ $T_J=125^\circ\text{C}$	$I_R$	5.0 100.0	$\mu\text{A}$
Maximum Reverse Recovery Time (Note 1)	$T_{rr}$	500	nS
$I^2t$ Rating for Fusing ( $t < 8.3\text{ms}$ )	$I^2t$	20.3	$\text{A}^2\text{Sec}$
Typical Junction Capacitance Per Leg (Note2)	$C_J$	15	pF
Typical Thermal Resistance (Note3)	$R_{JA}$ $R_{JC}$	65 22	$^\circ\text{C} / \text{W}$
Storage Temperature	$T_{STG}$	-55 to +150	$^\circ\text{C}$
Operating Junction Temperature	$T_J$	-55 to +150	$^\circ\text{C}$

#### Note:

1. Test Conditions:  $I_F=0.5\text{A}$ ,  $I_R=1.0\text{A}$ ,  $I_{RR}=0.25\text{A}$
2. Measured at 1.0 MHz and applied reverse voltage of 4.0Vdc
3. Thermal Resistance from Junction to Ambient and Case mounted on P.C.B with  $0.2 \times 0.2''$  ( $5 \times 5\text{mm}$ ) copper pads

# RATING AND CHARACTERISTIC CURVES

FIG.1-TYPICAL FORWARD CURRENT DERATING CURVE

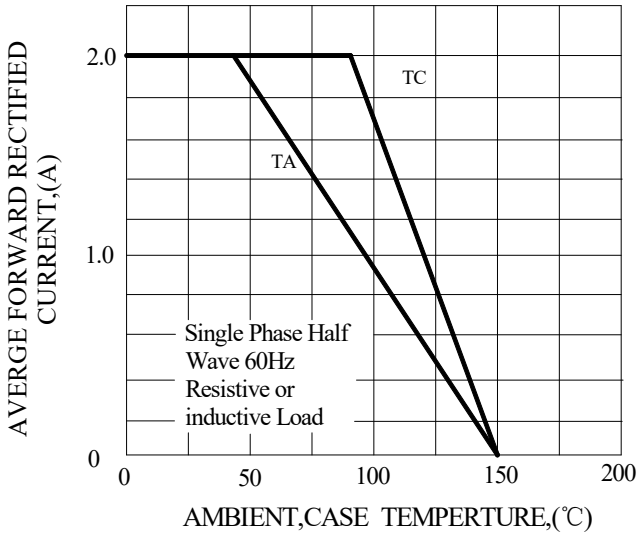

FIG.2-TYPICAL INSTANTANEOUS FORWARD CHARACTERISTICS

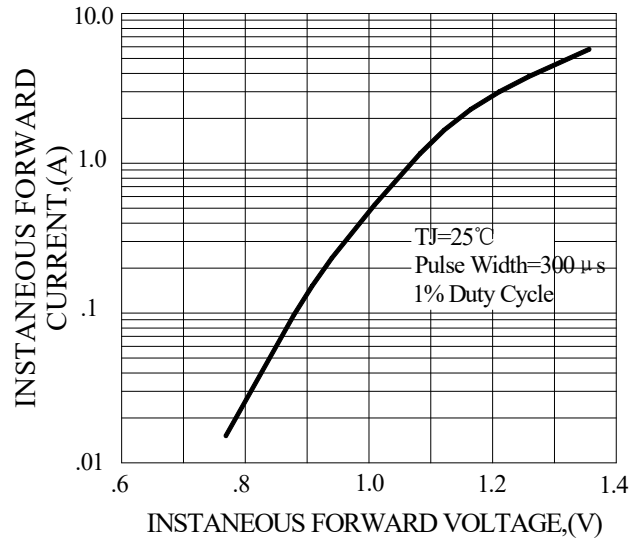

FIG.3-MAXIMUM NON-REPETITIVE FORWARD SURGE CURRENT

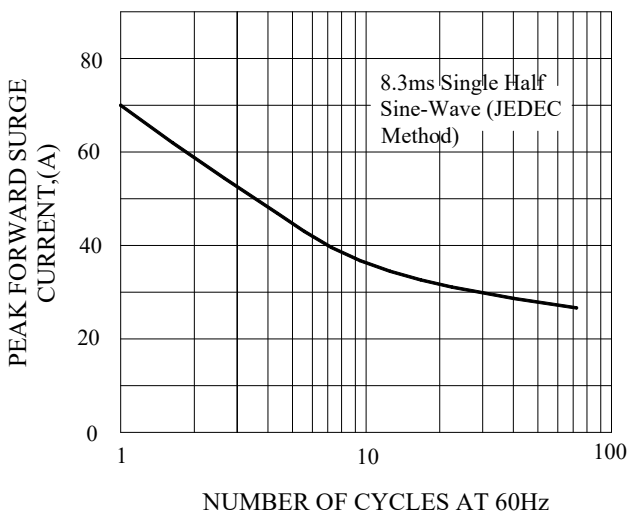

FIG.4-TYPICAL REVERSE CHARACTERISTICS

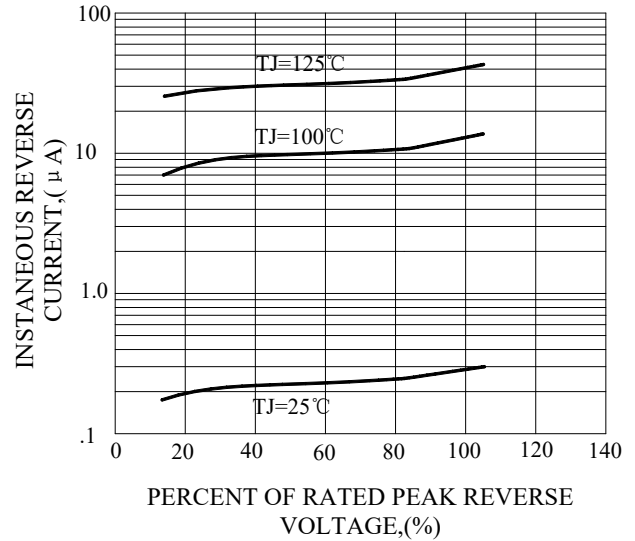
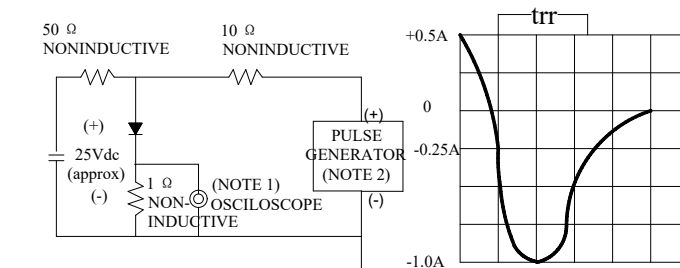

FIG.5-TEST CIRCUIT DIAGRAM AND REVERSE RECOVERY TIME CHARACTERISTIC



NOTES: 1. Rise Time=7ns max, Input Impedance= 1 megohm.22pF.  
2. Rise Time=10ns max, Source Impedance= 50 ohms.

## Marking and packaging illustration

### 1、Marking

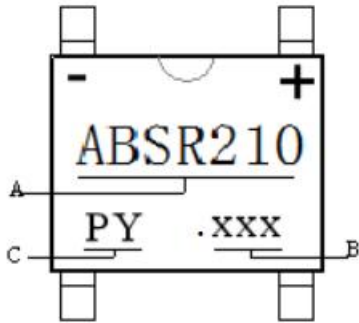

SYMBOL	Explanation
A	Product Name
B	Date Code
C	Trademark

### 2、Packaging

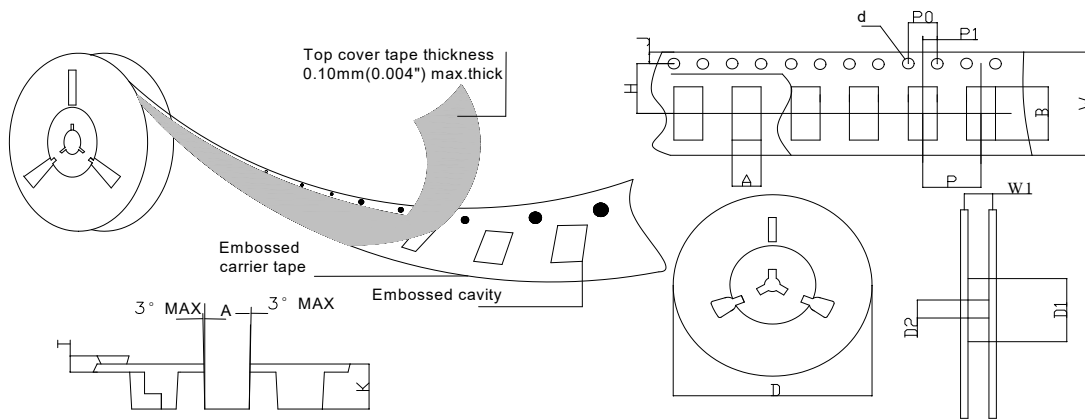

SPECIFICATIONS mm(inch)		PACKAGE	SPECIFICATIONS mm(inch)		PACKAGE
ITEM	SYM BOL	ABS	ITEM	SYM BOL	ABS
Carrier width	A	5.45(0.215)Max	Carrier depth	K	1.60(0.063)Typ
Carrier length	B	7.0(0.276)Max	Punch hole pitch	P	8.00(0.315)Typ
Sprocket hole	d	ø1.55(0.061)Typ	Sprocket hole pitch	P0	4.00(0.157)Typ
Reel outer diameter	D	330.0(13.0)Typ	Embossment center	P1	2.00(0.079)Typ
Reel inner diameter	D1	50.0(2.913)Min	Overall tape thickness	T	0.30(0.012)Typ
Feed hole diameter	D2	13.0(0.512)Typ	Tape width	W	12.0(0.472)Typ
Sprocket hole position	J	1.75(0.069)Typ	Reel width	W1	12.4(0.488)Min
Punch hole position	H	5.50(0.217)Typ			