

## TMBF410

### SINGLE PHASE 4.0 AMPS. GLASS PASSIVATED BRIDGE RECTIFIERS

#### FEATURE

- . Glass passivated junction.
- . Ideal for printed circuit board.
- . Reliable low cost construction utilizing molded plastic technique.
- . High surge current capability.
- . High temperature soldering guaranteed: 260°C/10 seconds at terminals.

#### MECHANICAL DATA

- . Case Material: "Green" Molding compound, UL flammability classification rating 94V-0, "Free halogen"
- . Moisture sensitivity level: level 1, per J-STD-020
- . Polarity: Polarity as marked on the body
- . Weight: 0.204g (approximately)

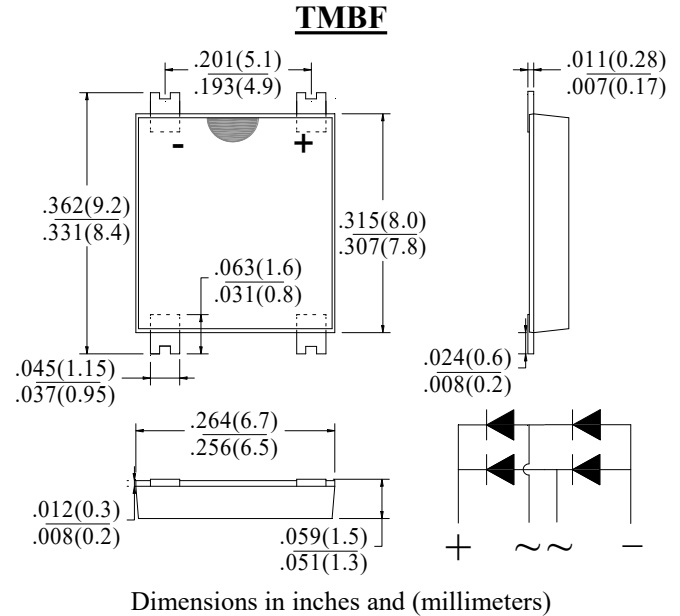

### MAXIMUM RATINGS AND ELECTRICAL CHARACTERISTICS

Ratings at 25°C ambient temperature unless otherwise specified.

Single phase, half wave, 60Hz, resistive or inductive load. For capacitive load, derate current by 20%

Type Number	SYM BOL	TMBF410	units
Maximum Recurrent Peak Reverse Voltage	$V_{RRM}$	1000	V
Maximum RMS Voltage	$V_{RMS}$	700	V
Maximum DC blocking Voltage	$V_{DC}$	1000	V
Maximum Average Forward rectified Current at $T_C=100^\circ\text{C}$	$I_{F(AV)}$	4.0	A
Peak Forward Surge Current @ $T_J=25^\circ\text{C}$	$I_{FSM}$	120	A
8.3ms single half sine-wave @ $T_J=125^\circ\text{C}$		100	
Peak Forward Surge Current @ $T_J=25^\circ\text{C}$	$I_{FSM}$	240	A
1.0ms single half sine-wave @ $T_J=125^\circ\text{C}$		200	
Maximum Forward Voltage @ 4.0A DC	$V_F$	1.1	V
Drop per element @ 2.0A DC		1.0	
Maximum DC Reverse Current @ $T_J=25^\circ\text{C}$	$I_R$	5.0	$\mu\text{A}$
at rated DC blocking voltage @ $T_J=125^\circ\text{C}$		500.0	
$I^2t$ Rating for Fusing ( $t < 8.3\text{ms}$ )	$I^2t$	59.7	$\text{A}^2\text{Sec}$
Typical Junction Capacitance Per Leg (Note1)	$C_J$	35	pF
Typical Thermal Resistance (Note2)	$R_{JA}$	55	$^\circ\text{C}/\text{W}$
	$R_{JC}$	10	
Storage Temperature	$T_{STG}$	-55 to +150	$^\circ\text{C}$
Operating Junction Temperature	$T_J$	-55 to +150	$^\circ\text{C}$

#### Note:

1. Measured at 1.0 MHz and applied reverse voltage of 4.0Vdc
2. Device mounted on PCB with 10 mm x 20 mm x 0.1mm copper pad areas

## Rating and Characteristic Curves

FIG.1-TYPICAL FORWARD CURRENT DERATING CURVE

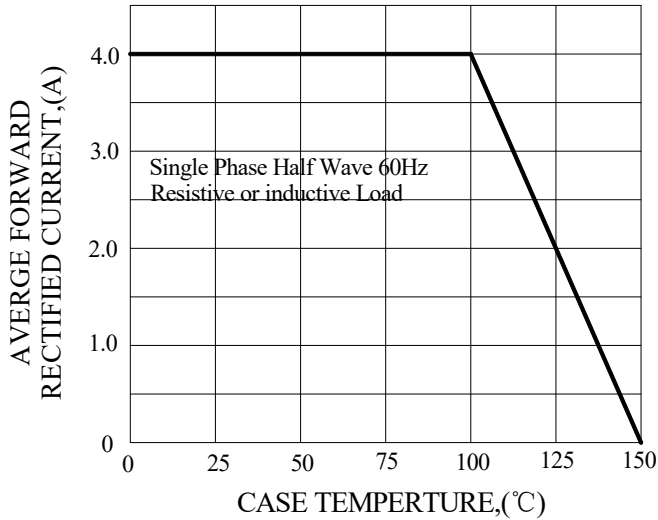

FIG.2-TYPICAL INSTANTANEOUS FORWARD CHARACTERISTICS

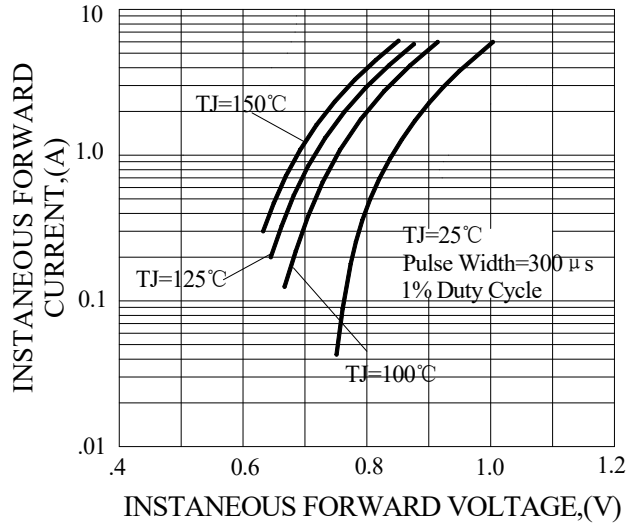

FIG.3-MAXIMUM NON-REPETITIVE FORWARD SURGE CURRENT

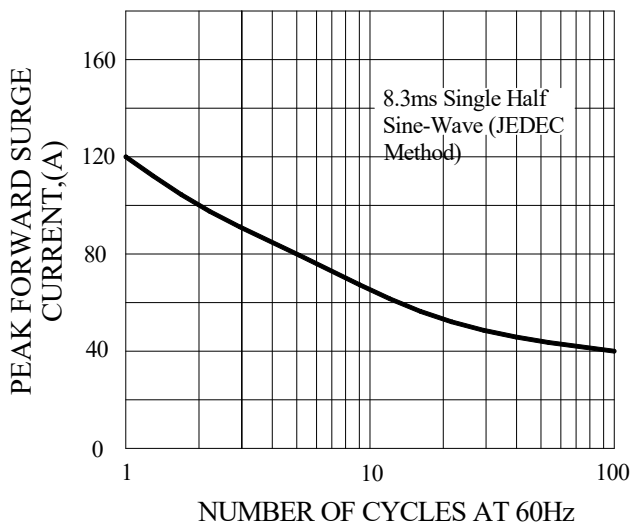

FIG.4-TYPICAL JUNCTION CAPACITANCE

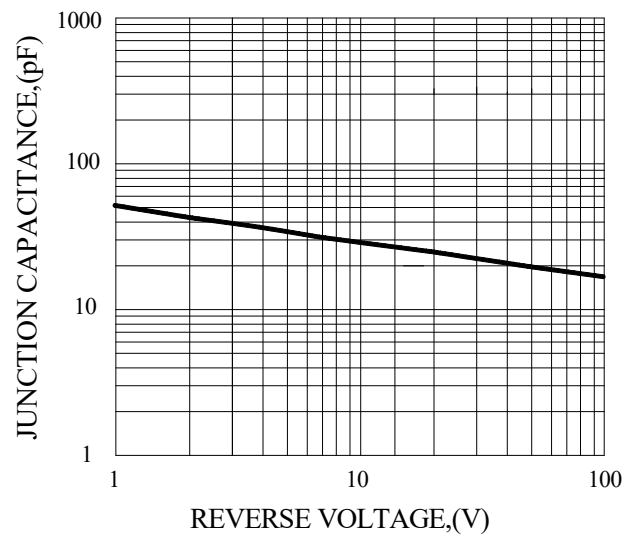
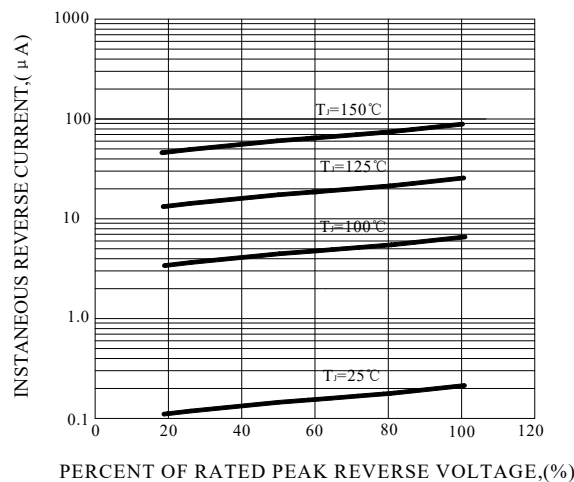
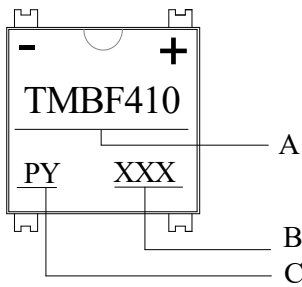

FIG.5-TYPICAL REVERSE CHARACTERISTICS



## Marking and packaging illustration

### 1、Marking



SYMBOL	Explanation
A	Product Name
B	Date Code
C	Trademark

### 2、Packaging

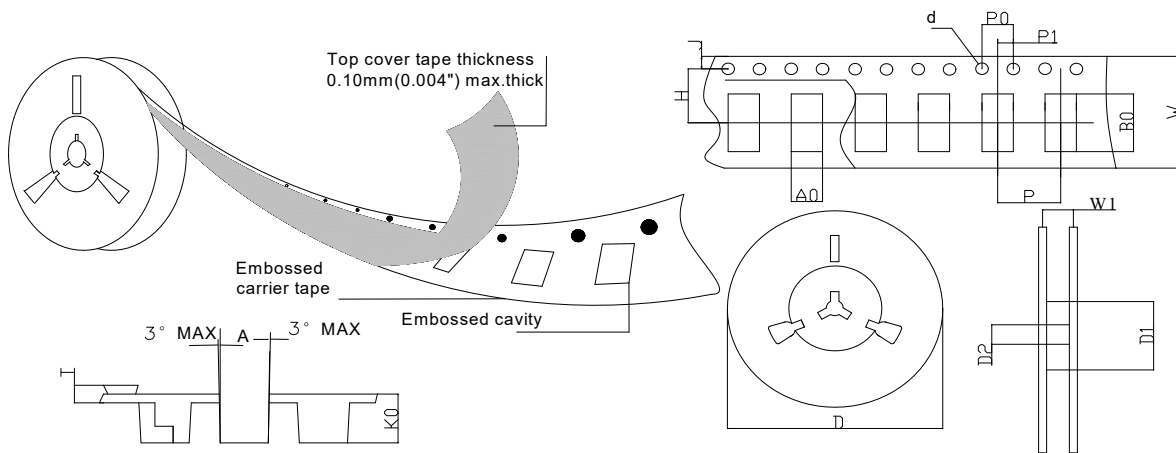

SPECIFICATIONS mm(inch)		PACKAGE	SPECIFICATIONS mm(inch)		PACKAGE
ITEM	SYM BOL	TMBF	ITEM	SYM BOL	TMBF
Carrier width	A	7.0(0.276)Max	Carrier depth	K	1.70(0.067)Typ
Carrier length	B	9.9(0.390)Max	Punch hole pitch	P	12.00(0.472)Typ
Sprocket hole	d	ø1.55(0.061)Typ	Sprocket hole pitch	P0	4.00(0.157)Typ
Reel outer diameter	D	330.0(13.0)Typ	Embossment center	P1	2.00(0.079)Typ
Reel inner diameter	D1	50.0(1.969)Min	Overall tape thickness	T	0.33(0.013)Typ
Feed hole diameter	D2	13.0(0.512)Typ	Tape width	W	16.0(0.630)Typ
Sprocket hole position	J	1.75(0.069)Typ	Reel width	W1	12.4(0.488)Min
Punch hole position	H	7.50(0.295)Typ			